



azeta

finiture / finishes / finitions / ausföhrungen / acabados

---

.015  
Cromo  
Chrome  
Chromé  
Verchromt  
Cromado





AZ830101



AC0984



AC0982



AZ860101



### AZ830101

BOX PCS. 12

Kg. 2,0



Miscelatore monocomando per lavabo con scarico 1"1/4 con flex inox cm 50 att. 3/8" F.

Single lever washbasin mixer with 1"1/4 pop-up waste and 3/8" F flex. hoses cm 50.

Mitigeur de lavabo avec vidage automatique 1"1/4 et flexibles d'alimentation cm 50 3/8" F.

Einhebelmischer Waschtischbatterie mit Ablaufgarnitur 1"1/4 und flex. Anschlussschläuchen cm 50 3/8" F.

Monomando para lavabo con desagüe 1"1/4, tubo flexible inoxidable de 50 cm, empalme 3/8" F.

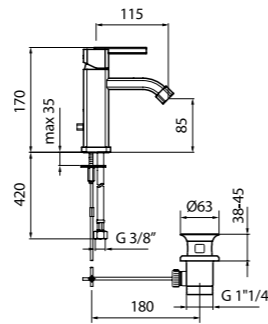

flex AC0447

AC0459015

Ø 25 mm AC0355000

### AZ830102

.015 Cromo / Chrome / Chromé / Verchromt / Cromado

### AZ830401

BOX PCS. 4

Kg. 3,2



Miscelatore monocomando per lavabo alto con scarico up & down; flex inox cm 70 att. 3/8" F.

High single lever washbasin mixer with up & down pop-up waste, with 3/8" flex. hoses 70 cm.

Mitigeur de lavabo haut avec vidage up & down, flexibles d'alimentation cm 70 3/8" F.

Einhebelmischer Waschtischbatterie, mit Ausführung, mit up & down Ablaufgarnitur, mit Flex. Anschlussschläuchen cm 70 3/8" F.

Monomando para lavabo alto con valvula click-clack, tubo flexible inoxidable de 70 cm, empalme 3/8" F.

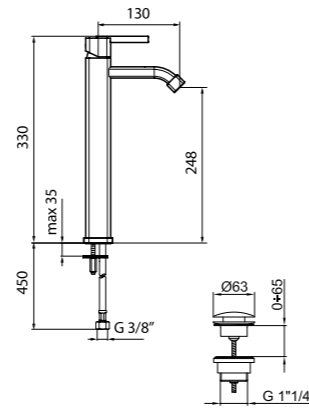

flex AC0448

AC0459015

Ø 25 mm AC0355000

### AZ830402

.015 Cromo / Chrome / Chromé / Verchromt / Cromado

### AZ830606

BOX PCS. 12

Kg. 2,4



Miscelatore monocomando per lavabo incasso muro, con piastra orizzontale, senza scarico e flessibili.

Concealed single lever washbasin mixer, horizontal cover plate, without pop-up waste and flex hoses.

Mitigeur de lavabo à encastrer, rosace horizontale, sans vidage et flexibles.

Einhebelmischer Unterputz-Waschtischbatterie waagerechte Rosette, ohne Ablaufgarnitur und flex. Anschlussschläuchen.

Monomando empotrable para lavabo de pared, con placa horizontal, sin desagüe ni tubos flexibles.

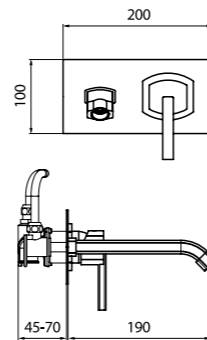

AC0356015

AC0459015

Ø 35 mm AC0338000

.015 Cromo / Chrome / Chromé / Verchromt / Cromado

### AZ850101

BOX PCS. 6

Kg. 3,3



Miscelatore monocomando per vasca esterno completo con flessibile in ottone da 150 cm doccetta anticalcare e supporto.

Single lever bath mixer with shower set complete of brass hose 150 cm, handshower and holder.

Mitigeur bain-douche complet de flexible 150 cm, douchette et support mural.

Einhebelmischer Badebatterie mit Brausegarnitur bestehend aus Metall-Brauseschlauch 150 cm, Handbrause und Wandhalterung.

Monomando externo para bañera completo, con tubo flexible de latón de 150 cm, ducha a prueba de incrustaciones y soporte.

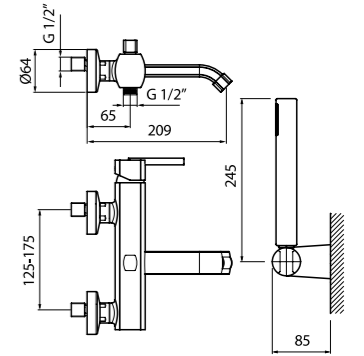

AC0822015

AC0459015

Ø 35 mm AC0338000

153 + € 15,00

.015 Cromo / Chrome / Chromé / Verchromt / Cromado

### AZ850401

BOX PCS. 1

Kg. 7,3



Miscelatore monocomando per vasca esterno, con colonne a pavimento, flessibile e doccetta.

Bath mixer with floor connections and shower set.

Mitigeur bain/douche avec raccords sur pieds et garniture de douche.

Einhebelmischer Badebatterie mit Standverschraubungen und Brausegarnitur.

Monomando externo para bañera, con columnas de toma de agua al pavimento.

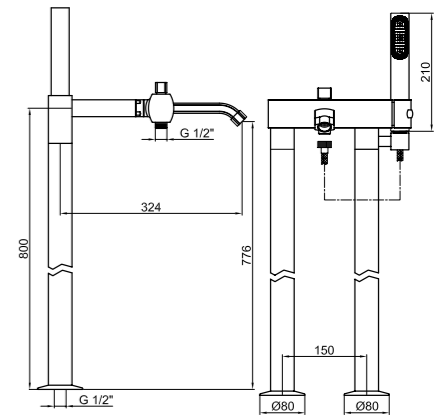

AC0822015

AC0459015

Ø 35 mm AC0338000

.015 Cromo / Chrome / Chromé / Verchromt / Cromado

### AZ840101

BOX PCS. 12

Kg. 1,8



Miscelatore monocomando per bidet con scarico 1"1/4 con flex inox cm 50 att. 3/8" F.

Single lever bidet mixer with 1"1/4 pop-up waste and 3/8" F flex. hoses cm 50.

Mitigeur de bidet avec vidage automatique 1"1/4 et flexibles d'alimentation cm 50 3/8" F.

Einhebelmischer Bidetbatterie mit Ablaufgarnitur 1"1/4 und flex. Anschlussschläuchen cm 50 3/8" F.

Monomando para bidé con desagüe 1"1/4, tubo flexible inoxidable de 50 cm, empalme 3/8" F.

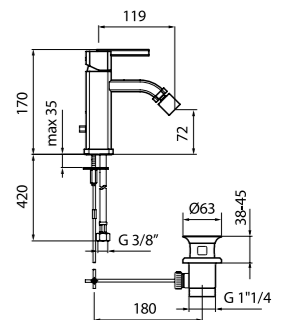

flex AC0447

AC0745015

Ø 25 mm AC0355000

.015 Cromo / Chrome / Chromé / Verchromt / Cromado

AZ840102

### AZ870105

BOX PCS. 1

 Kg. 6,8

 Kg. 2,4



Miscelatore monocomando per doccia esterno, versione completa di colonna, soffione e doccetta monogetto.

Shower mixer with column, shower head and monospray handshower.

Mitigeur de douche avec colonne, pomme de douche et douchette monojet.

Einhebelmischer Brausebatterie mit Brausegleitstange, Brausekopf und 1 Funktion Handbrause.

Monomando externo para ducha, versión con columna, rociador y ducha.

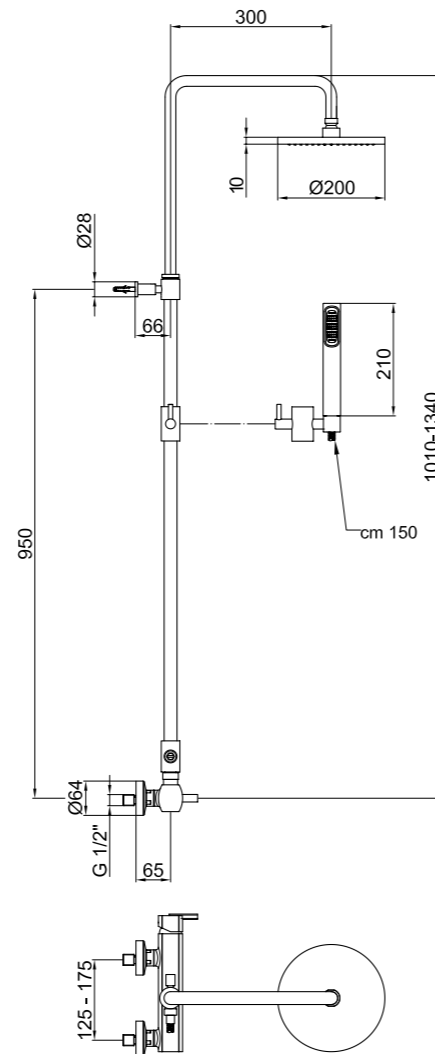

PVC .015 Cromo / Chrome / Chromé / Verchromt / Cromado

METAL .015 Cromo / Chrome / Chromé / Verchromt / Cromado

 Ø 35 mm  
AC0338000

**153** + € 15,00

### AZ870102

BOX PCS. 6

 Kg. 2,4



Miscelatore monocomando per doccia esterno; senza flessibile, doccetta e gancio di supporto.

Single lever shower mixer without shower set.

Mitigeur de douche sans garniture de douche.

Einhebelmischer Brausebatterie ohne Brausegarnitur.

Monomando externo para ducha, sin tubo flexible, ducha ni gancho de soporte.

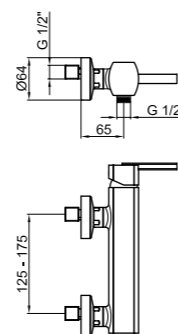

.015 Cromo / Chrome / Chromé / Verchromt / Cromado

 Ø 35 mm  
AC0338000

**153** + € 15,00

### AZ880101

BOX PCS. 12

 Kg. 1,4



Miscelatore monocomando per doccia incasso, con piastra, senza flessibile, doccetta e gancio.

Concealed single lever shower mixer with cover plate, without shower set.

Mitigeur de douche à encastrer avec rosace, sans garniture de douche.

Einhebelmischer Unterputz-Brausebatterie, mit Rosette ohne Brausegarnitur.

Monomando empotrable para ducha, con placa, sin tubo flexible, ducha ni gancho.

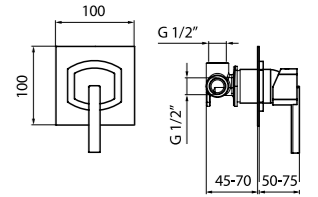

.015 Cromo / Chrome / Chromé / Verchromt / Cromado

 AC03590015

 Ø 35 mm  
AC0338000

### AZ860101

BOX PCS. 12

 Kg. 2,3



Miscelatore monocomando per vasca incasso, con deviatore, piastra; senza flessibile doccetta e gancio di supporto.

Concealed single lever bath mixer with diverter, cover plate, without shower set.

Mitigeur bain-douche à encastrer avec inverseur, rosace, sans garniture de douche.

Einhebelmischer Unterputz-Badebatterie mit Umstellung, Rosette, ohne Brausegarnitur.

Monomando empotrable para bañera, con desviador, placa, sin tubo flexible, ducha ni gancho de soporte.

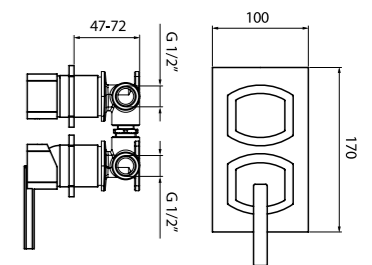

 AC0357015

 AC0329000

 Ø 35 mm  
AC0338000

.015 Cromo / Chrome / Chromé / Verchromt / Cromado

### AZ880601

BOX PCS. 12

 Kg. 2,4



Miscelatore monocomando per doccia incasso, con deviatore 3 vie.

Concealed single lever shower mixer, with 3-ways diverter.

Mitigeur de douche encastré avec inverseur 3 voies.

Einhebelmischer Unterputz-Brausebatterie mit 3 Wegeumsteller.

Monomando empotrable para ducha, con desviador 3 vías.

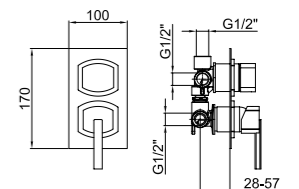

 AC0357015

 AC0335000

 Ø 35 mm  
AC0338000

.015 Cromo / Chrome / Chromé / Verchromt / Cromado